

描述 / Descriptions

TO-126F 塑封封装 NPN 半导体三极管。Silicon NPN transistor in a TO-126F Plastic Package.

特征 / Features

$V_{CE(sat)}$ 低, 与 2SA885 互补可得到 3W 输出。

Low $V_{CE(sat)}$, 3W output in complementary pair with 2SA885.

用途 / Applications

用于中功率放大。

Medium power amplifier.

内部等效电路 / Equivalent Circuit



引脚排列 / Pinning



PIN 1 : Emitter

PIN 2 : Collector

PIN 3 : Base

放大及印章代码 / h_{FE} Classifications & Marking

| h_{FE} Classifications Symbol | Q | R | S |
|------------------------------------|--------|---------|---------|
| h_{FE} Range | 85~170 | 120~240 | 170~340 |

极限参数 / Absolute Maximum Ratings(Ta=25°C)

| 参数 Parameter | 符号 Symbol | 数值 Rating | 单位 Unit |
|---------------------------------------|--------------|--------------|------------|
| Collector to Base Voltage | V_{CBO} | 45 | V |
| Collector to Emitter Voltage | V_{CEO} | 35 | V |
| Emitter to Base Voltage | V_{EBO} | 5.0 | V |
| Collector Current - Continuous | I_C | 1.0 | A |
| Collector Current – Continuous(Pulse) | I_{CP} | 1.5 | A |
| Collector Power Dissipation | * P_C | 1.2 | W |
| Collector Power Dissipation | ** P_C | 5 | W |
| Junction Temperature | T_j | 150 | °C |
| Storage Temperature Range | T_{stg} | -55~150 | °C |

*Without heat sink

**With a 100×100×2mm AL heat sink

电性能参数 / Electrical Characteristics(Ta=25°C)

| 参数 Parameter | 符号 Symbol | 测试条件 Test Conditions | 最小值 Min | 典型值 Typ | 最大值 Max | 单位 Unit |
|---|---------------|---------------------------------|------------|------------|------------|------------|
| Collector to Base Breakdown Voltage | V_{CBO} | $I_C=1.0mA$ $I_E=0$ | 45 | | | V |
| Collector to Emitter Breakdown Voltage | V_{CEO} | $I_C=2.0mA$ $I_B=0$ | 35 | | | V |
| Collector Cut-Off Current | I_{CBO} | $V_{CB}=20V$ $I_E=0$ | | | 0.1 | μA |
| Collector Cut-Off Current | I_{CEO} | $V_{CE}=20V$ $I_B=0$ | | | 100 | μA |
| Emitter Cut-Off Current | I_{EBO} | $V_{EB}=5.0V$ $I_C=0$ | | | 10 | μA |
| DC Current Gain | $h_{FE(1)}$ | $V_{CE}=10V$ $I_C=500mA$ | 85 | 160 | 340 | |
| | $h_{FE(2)}$ | $V_{CE}=5.0V$ $I_C=1.0A$ | 50 | | | |
| Collector to Emitter Saturation Voltage | $V_{CE(sat)}$ | $I_C=500mA$ $I_B=50mA$ | | | 0.5 | V |
| Transition Frequency | f_T | $V_{CE}=10V$ $I_C=50mA$ | | 200 | | MHz |
| Reverse Transfer Capacitance | C_{ob} | $V_{CB}=10V$ $f=1.0MHz$ $I_E=0$ | | | 20 | pF |

电参数曲线图 / Electrical Characteristic Curve

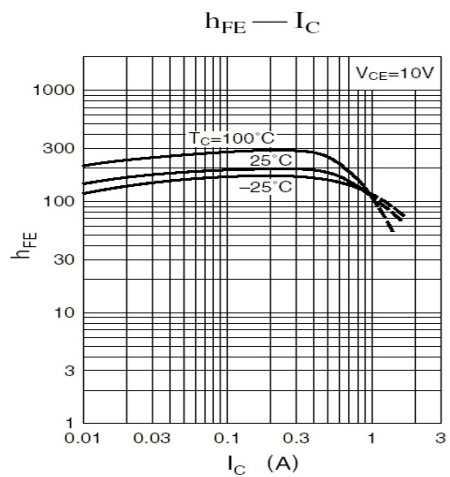
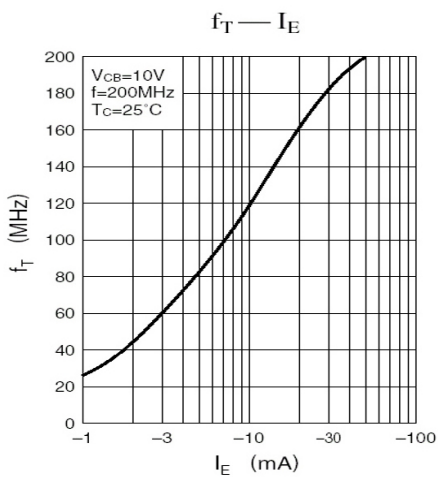
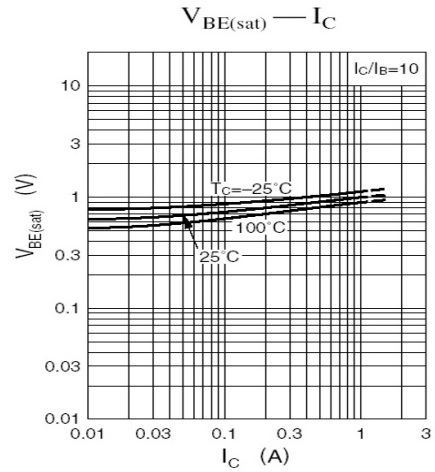
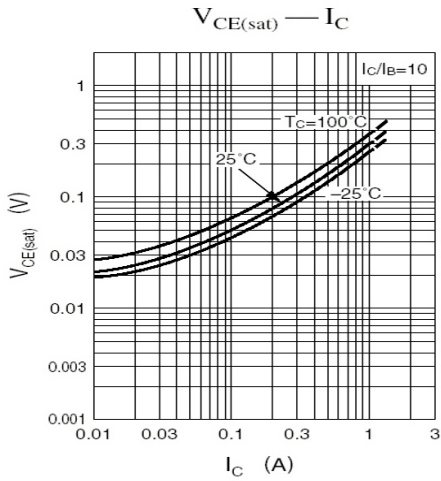
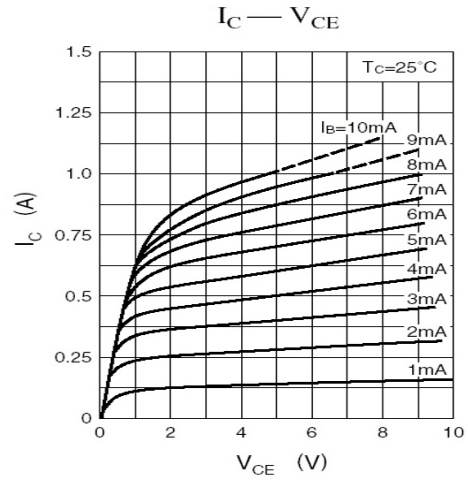
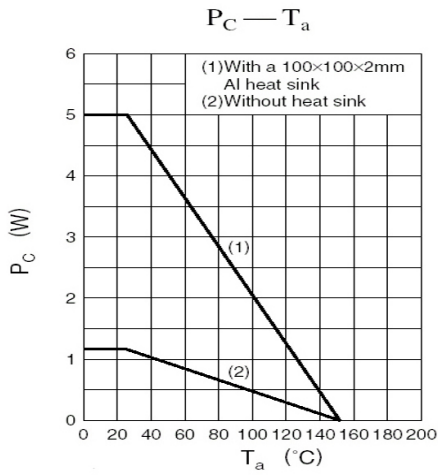

外形尺寸图 / Package Dimensions

T0-126F

单位: mm

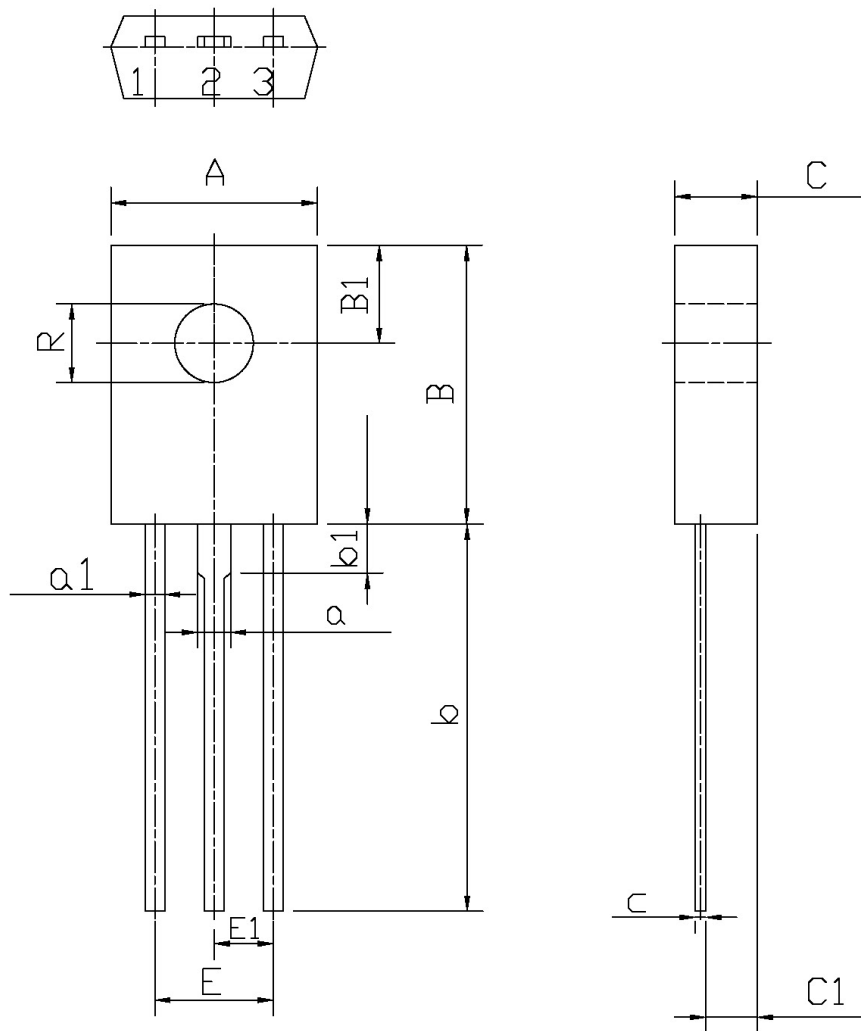

| Symbol | Dimensions In Millimeters | | Symbol | Dimensions In Millimeters | |
|--------|---------------------------|------|--------|---------------------------|------|
| | Min | Max | | Min | Max |
| A | 7.8 | 8.2 | a1 | 0.66 | 0.86 |
| B | 10.8 | 11.2 | E | 4.4 | 4.8 |
| B1 | 3.8 | 4.2 | C | 3.1 | 3.3 |
| R | 2.95 | 3.15 | C1 | 1.9 | 2.1 |
| b | 14 | 16 | c | 0.3 | 0.6 |
| b1 | 1.9 | | a | 1.27 | |
| E1 | 2.1 | 2.5 | | | |

印章说明 / Marking Instructions

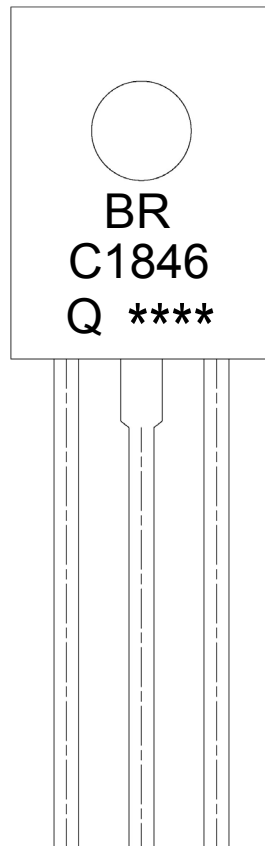

说明：

BR： 为公司代码

C1846： 为型号代码

Q： 为 h_{FE} 分档代码

****： 为生产批号代码，随生产批号变化。

Note:

BR: Company Code

C1846: Product Type.

Q: h_{FE} Classifications Symbol

****: Lot No. Code, code change with Lot No.

波峰焊温度曲线图(无铅) / Temperature Profile for Dip Soldering(Pb-Free)



说明：

- 1、预热温度 25 ~ 150°C，时间 60 ~ 90sec；
- 2、峰值温度 255±5°C，时间持续为 5±0.5sec；
- 3、焊接制程冷却速度为 2 ~ 10°C/sec.

Note:

- 1.Preheating:25~150°C, Time:60~90sec.
- 2.Peak Temp.:255±5°C, Duration:5±0.5sec.
3. Cooling Speed: 2~10°C/sec.

耐焊接热试验条件 / Resistance to Soldering Heat Test Conditions

温度：270±5°C

时间：10±1 sec.

Temp.:270±5°C

Time:10±1 sec

包装规格 / Packaging SPEC.

散件包装 / BULK

| Package Type 封装形式 | Units 包装数量 | | | | | Dimension 包装尺寸 (unit: mm ³) | | |
|----------------------|--------------------|-------------------------|------------------------|------------------------------|------------------------|---|-------------|-------------|
| | Units/Tube 只/套管 | Tubes/Inner Box 套管/盒 | Units/Inner Box 只/盒 | Inner Boxes/Outer Box 盒/箱 | Units/Outer Box 只/箱 | Tube 套管 | Inner Box 盒 | Outer Box 箱 |
| TO-126/F | 500 | 6 | 3,000 | 5 | 15,000 | 135×190 | 237×172×102 | 560×245×195 |

套管包装 / TUBE

| Package Type 封装形式 | Units 包装数量 | | | | | Dimension 包装尺寸 (unit: mm ³) | | |
|----------------------|--------------------|-------------------------|------------------------|------------------------------|------------------------|---|-------------|-------------|
| | Units/Tube 只/套管 | Tubes/Inner Box 套管/盒 | Units/Inner Box 只/盒 | Inner Boxes/Outer Box 盒/箱 | Units/Outer Box 只/箱 | Tube 套管 | Inner Box 盒 | Outer Box 箱 |
| TO-126/F | 65 | 26 | 1,690 | 5 | 8,450 | 532×31×5.6 | 555×164×50 | 575×290×180 |

使用说明 / Notices