

描述 / Descriptions

TO-126F 塑封封装 NPN 半导体三极管。Silicon NPN transistor in a TO-126F Plastic Package.

特征 / Features

耐压高,高频特性好。

High breakdown voltage, excellent high frequency Characteristic.

用途 / Applications

高清晰度显像管视频输出,彩电色度输出和高击穿电压驱动。

High-definition CRT display, color TV chroma output and high breakdown voltage driver.

内部等效电路 / Equivalent Circuit



引脚排列 / Pinning



PIN1 : Emitter

PIN 2 : Collector

PIN 3 : Base

放大及印章代码 / h_{FE} Classifications & Marking

h_{FE} Classifications Symbol	C	O	E	F
h_{FE} Range	40~80	60~120	100~200	160~320

极限参数 / Absolute Maximum Ratings(Ta=25°C)

参数 Parameter	符号 Symbol	数值 Rating	单位 Unit
Collector to Base Voltage	V_{CBO}	300	V
Collector to Emitter Voltage	V_{CEO}	300	V
Emitter to Base Voltage	V_{EBO}	5.0	V
Collector Current - Continuous	I_C	100	mA
Collector Current – Continuous(Pulse)	I_{cp}	200	mA
Collector Power Dissipation	P_C	1.2	W
Collector Power Dissipation	$P_C(T_c=25^\circ C)$	7.0	W
Junction Temperature	T_j	150	°C
Storage Temperature Range	T_{stg}	-55~150	°C

电性能参数 / Electrical Characteristics(Ta=25°C)

参数 Parameter	符号 Symbol	测试条件 Test Conditions	最小值 Min	典型值 Typ	最大值 Max	单位 Unit
Collector to Base Breakdown Voltage	V_{CBO}	$I_C=10\mu A$ $I_E=0$	300			V
Collector to Emitter Breakdown Voltage	V_{CEO}	$I_C=1.0mA$ $I_B=0$	300			V
Emitter to Base Breakdown Voltage	V_{EBO}	$I_E=10\mu A$ $I_C=0$	5.0			V
Collector Cut-Off Current	I_{CBO}	$V_{CB}=200V$ $I_E=0$			0.1	μA
Emitter Cut-Off Current	I_{EBO}	$V_{EB}=4.0V$ $I_C=0$			0.1	μA
DC Current Gain	h_{FE}	$V_{CE}=10V$ $I_C=10mA$	40		320	
Collector to Emitter Saturation Voltage	$V_{CE(sat)}$	$I_C=20mA$ $I_B=2.0mA$			0.6	V
Base to Emitter Voltage	$V_{BE(sat)}$	$I_C=20mA$ $I_B=2.0mA$			1.0	V
Transition Frequency	f_T	$V_{CE}=30V$ $I_C=10mA$		70		MHz
Collector Output Capacitance	C_{ob}	$V_{CB}=30V$ $I_E=0$ $f=1.0MHz$		2.6		pF
Reverse Transfer Capacitance	C_{re}	$V_{CB}=30V$ $f=1.0MHz$		1.8		pF

电参数曲线图 / Electrical Characteristic Curve

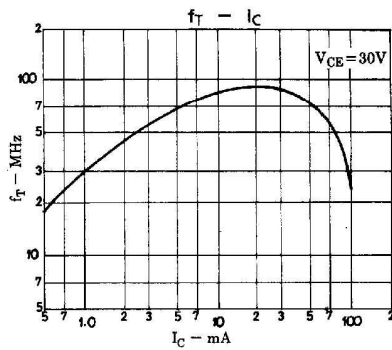
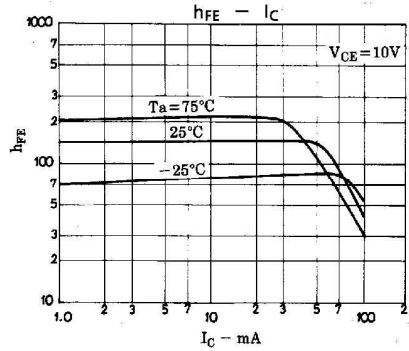
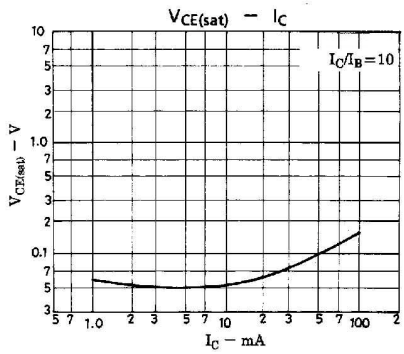
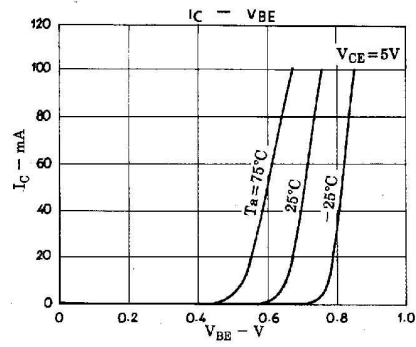
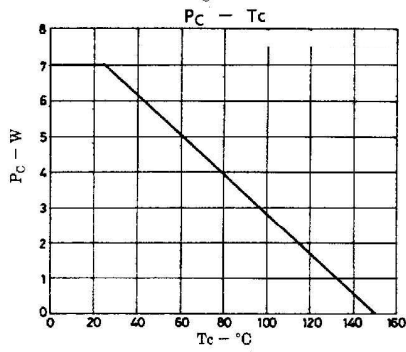
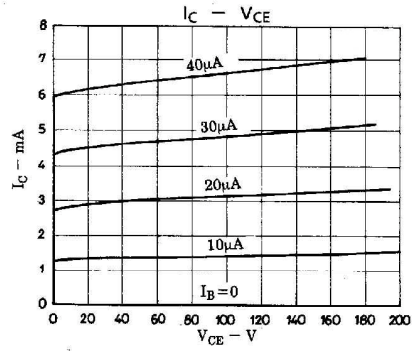
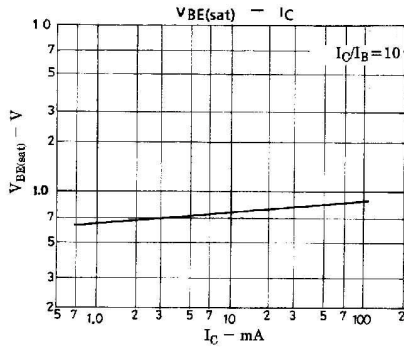

外形尺寸图 / Package Dimensions

T0-126F

单位: mm

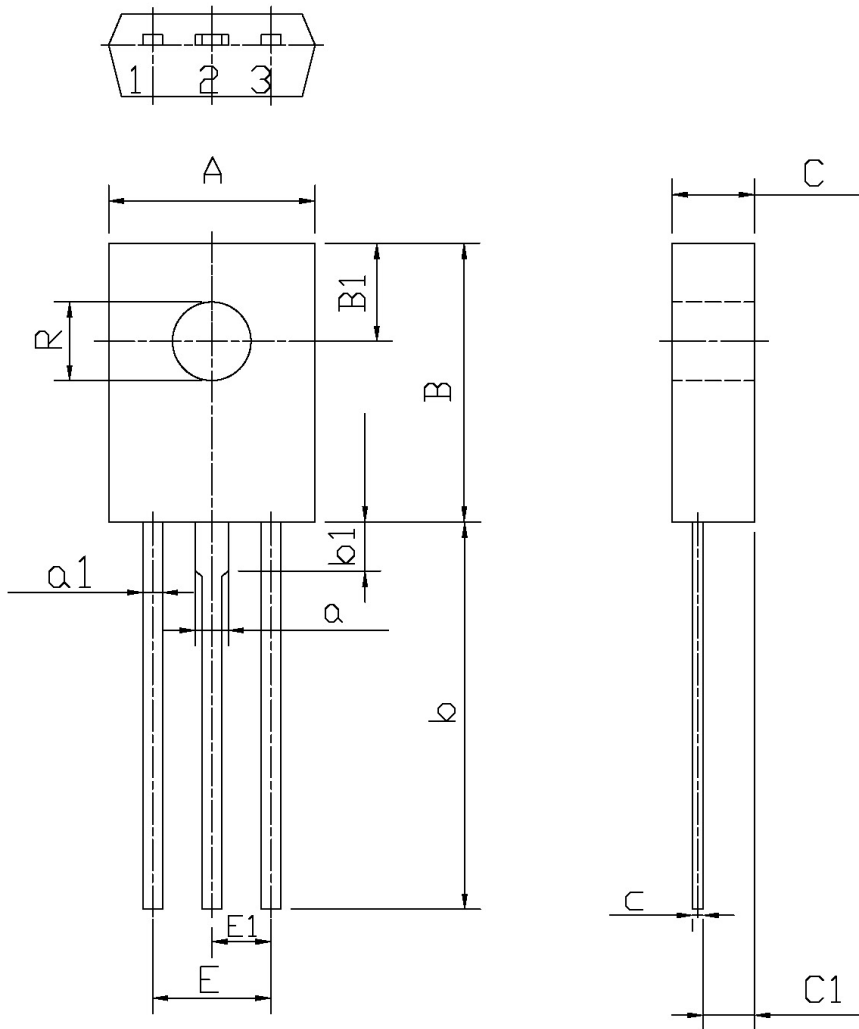

Symbol	Dimensions In Millimeters		Symbol	Dimensions In Millimeters	
	Min	Max		Min	Max
A	7.8	8.2	a1	0.66	0.86
B	10.8	11.2	E	4.4	4.8
B1	3.8	4.2	C	3.1	3.3
R	2.95	3.15	C1	1.9	2.1
b	14	16	c	0.3	0.6
b1	1.9		a	1.27	
E1	2.1	2.5			

印章说明 / Marking Instructions

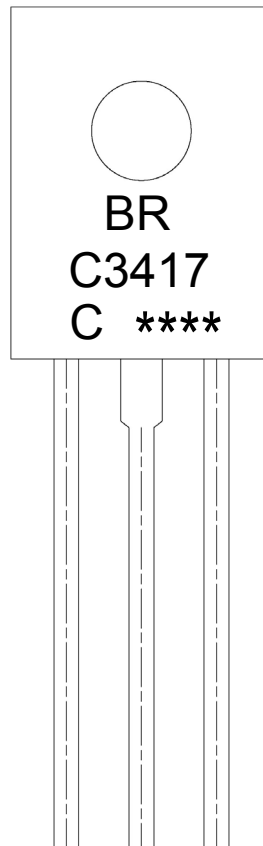

说明：

BR： 为公司代码

C3417： 为型号代码

C： 为 h_{FE} 分档代码

****： 为生产批号代码，随生产批号变化。

Note:

BR: Company Code

C3417: Product Type.

C: h_{FE} Classifications Symbol

****: Lot No. Code, code change with Lot No.

波峰焊温度曲线图(无铅) / Temperature Profile for Dip Soldering(Pb-Free)



说明：

- 1、预热温度 25 ~ 150°C，时间 60 ~ 90sec;
- 2、峰值温度 255±5°C，时间持续为 5±0.5sec;
- 3、焊接制程冷却速度为 2 ~ 10°C/sec.

Note:

- 1.Preheating:25~150°C, Time:60~90sec.
- 2.Peak Temp.:255±5°C, Duration:5±0.5sec.
3. Cooling Speed: 2~10°C/sec.

耐焊接热试验条件 / Resistance to Soldering Heat Test Conditions

温度：270±5°C

时间：10±1 sec.

Temp.:270±5°C

Time:10±1 sec

包装规格 / Packaging SPEC.

散件包装 / BULK

Package Type 封装形式	Units 包装数量					Dimension 包装尺寸 (unit: mm ³)		
	Units/Tube 只/套管	Tubes/Inner Box 套管/盒	Units/Inner Box 只/盒	Inner Boxes/Outer Box 盒/箱	Units/Outer Box 只/箱	Tube 套管	Inner Box 盒	Outer Box 箱
TO-126/F	500	6	3,000	5	15,000	135×190	237×172×102	560×245×195

套管包装 / TUBE

Package Type 封装形式	Units 包装数量					Dimension 包装尺寸 (unit: mm ³)		
	Units/Tube 只/套管	Tubes/Inner Box 套管/盒	Units/Inner Box 只/盒	Inner Boxes/Outer Box 盒/箱	Units/Outer Box 只/箱	Tube 套管	Inner Box 盒	Outer Box 箱
TO-126/F	65	26	1,690	5	8,450	532×31×5.6	555×164×50	575×290×180

使用说明 / Notices