

BRD4N65S

Rev.A Dec.-2023

描述 / Descriptions

TO-252 塑封封装 N 沟道 MOS 场效应管。
N-CHANNEL MOSFET in a TO-252 Plastic Package.

特征 / Features

低栅电荷,低反馈电容,开关速度快,无卤产品,具有良好的电磁干扰性能,无卤产品。
Low gate charge, low crss, fast switching, HF Product. Have good Electromagnetic Interference performance, HF Product.

用途 / Applications

该器件适用于适配器和充电器的功率开关电路
These devices are well suited for power switch circuit of adaptor and charger.

内部等效电路 / Equivalent Circuit

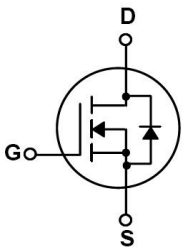

引脚排列 / Pinning

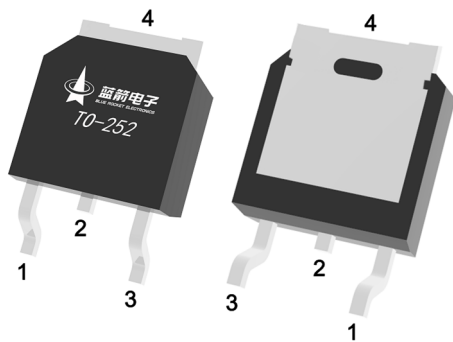

PIN 1 : G

PIN 2 : D

PIN 3 : S

PIN 4 : D

印章代码 / Marking

见印章说明。
See Marking Instructions.

极限参数 / Absolute Maximum Ratings(Ta=25°C)

| 参数 Parameter | 符号 Symbol | 数值 Rating | 单位 Unit |
|---|-----------------------------|--------------|--------------------|
| Drain-Source Voltage | V_{DS} | 650 | V |
| Drain Current | $I_D(T_c=25^\circ\text{C})$ | 4.0 | A |
| Drain Current - Pulsed | I_{DM} | 16 | A |
| Gate-Source Voltage | V_{GS} | ± 30 | V |
| Single Pulsed Avalanche Energy | E_{AS} | 160 | mJ |
| Avalanche Current | I_{AR} | 6.0 | A |
| Power Dissipation | $P_D(T_c=25^\circ\text{C})$ | 75 | W |
| Operating and Storage Temperature Range | T_J, T_{STG} | -55 to 150 | $^\circ\text{C}$ |
| Junction to Ambient | $R_{\theta JA}$ | 100 | $^\circ\text{C/W}$ |
| Junction to Case | $R_{\theta JC}$ | 1.7 | $^\circ\text{C/W}$ |

电性能参数 / Electrical Characteristics(Ta=25°C)

| 参数 Parameter | 符号 Symbol | 测试条件 Test Conditions | 最小值 Min | 典型值 Typ | 最大值 Max | 单位 Unit |
|------------------------------------|--------------|---|------------|------------|------------|------------|
| Drain-Source Breakdown Voltage | BV_{DSS} | $V_{GS}=0V$ $I_D=250\mu A$ | 650 | 680 | | V |
| Zero Gate Voltage Drain Current | I_{DSS} | $V_{DS}=650V$ $V_{GS}=0V$ | | | 1 | μA |
| Gate-Body Leakage Current Forward | I_{GSS} | $V_{GS}=\pm 30V$ $V_{DS}=0V$ | | | ± 100 | nA |
| Gate Threshold Voltage | $V_{GS(th)}$ | $V_{DS}=V_{GS}$ $I_D=250\mu A$ | 2.0 | 3.3 | 4.0 | V |
| Static Drain-Source On-Resistance | $R_{DS(on)}$ | $V_{GS}=10V$ $I_D=2.0A$ | | 2.2 | 2.7 | Ω |
| Input Capacitance | C_{iss} | $V_{DS}=25V$ $V_{GS}=0V$ $f=1.0MHz$ | | 570 | | pF |
| Output Capacitance | C_{oss} | | | 44 | | |
| Reverse Transfer Capacitance | C_{rss} | | | 3 | | |
| Total Gate Charge | Q_G | $V_{DS}=520V,$ $I_D=4.0A,$ $V_{GS}=10V$ | | 102 | | nC |
| Gate-Source Charge | Q_{GS} | | | 18 | | |
| Gate-Drain Charge | Q_{GD} | | | 22 | | |
| Turn-On Delay Time | $t_{d(on)}$ | $V_{DD}=325V$ $I_D=4.0A$ $R_G=25\Omega$ $V_{GS}=10V$ | | 48 | | ns |
| Turn-On Rise Time | t_r | | | 102 | | |
| Turn-Off Delay Time | $t_{d(off)}$ | | | 205 | | |
| Turn-Off Fall Time | t_f | | | 134 | | |
| Drain-Source Diode Forward Voltage | V_{SD} | $V_{GS}=0V,$ $I_S=4.0A$ | | | 1.4 | V |

电参数曲线图 / Electrical Characteristic Curve

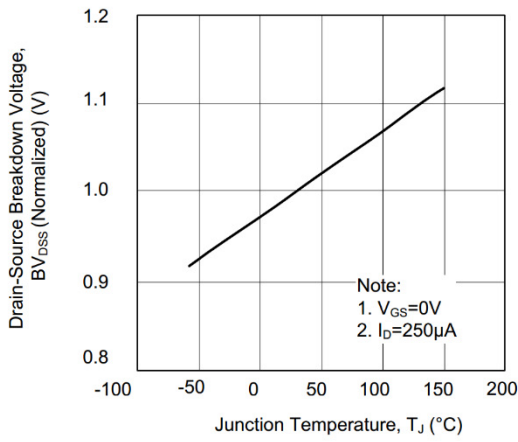

1. Breakdown Voltage Variation vs. Temperature

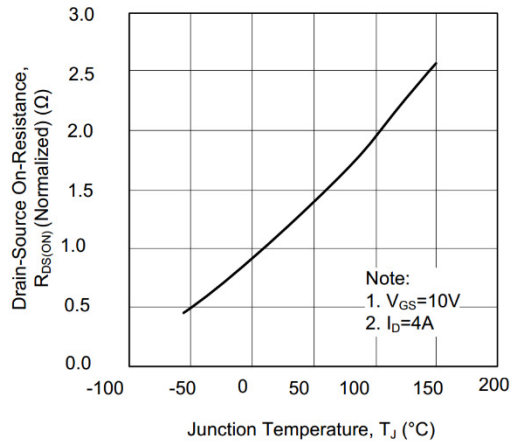

2. On-Resistance Junction Temperature

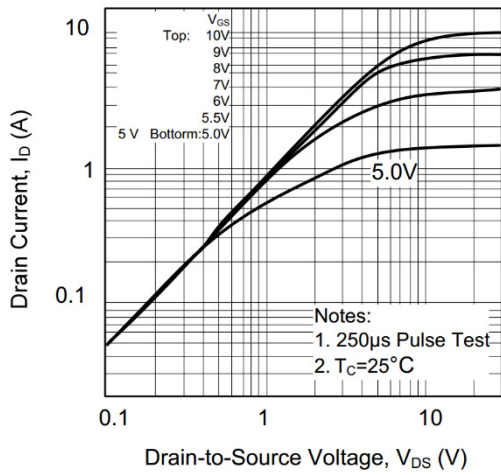

3. On-State Characteristics

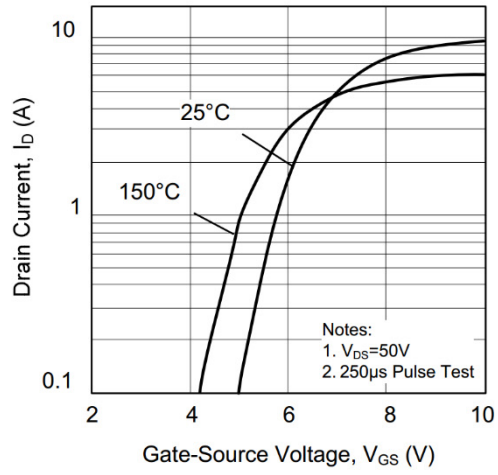

4. Transfer Characteristics

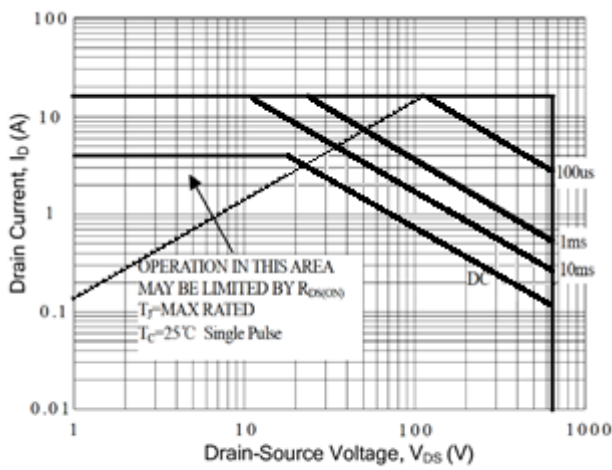

5. Safe Operating Area

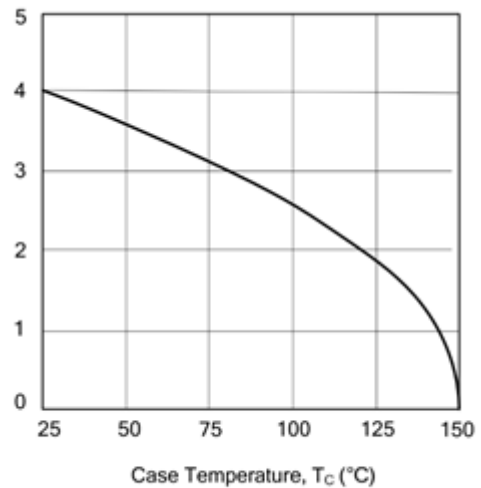

6. Maximum Drain Current vs. Case Temperature

外形尺寸图 / Package Dimensions

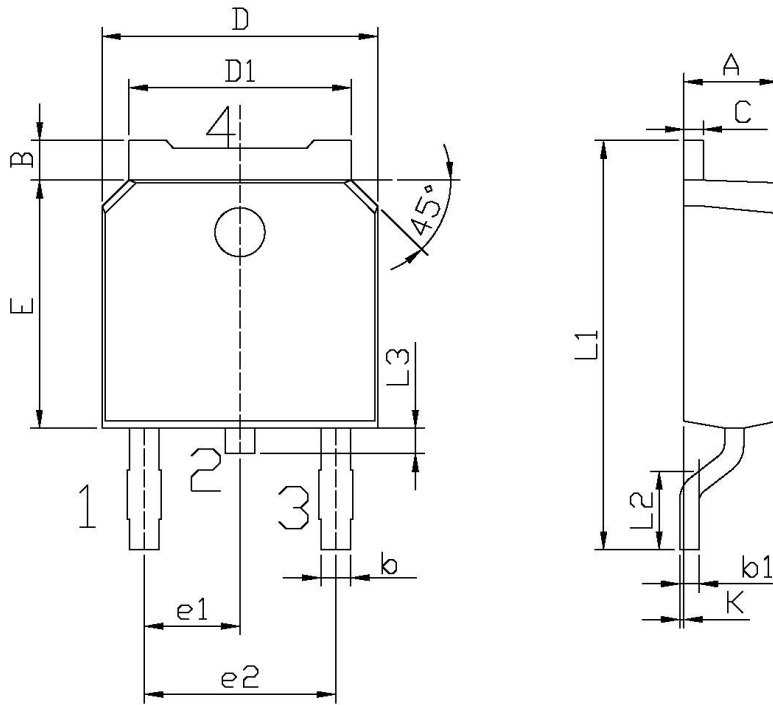

单位: mm

| Symbol | Dimensions In Millimeters | | Symbol | Dimensions In Millimeters | |
|--------|---------------------------|------|--------|---------------------------|-------|
| | Min | Max | | Min | Max |
| A | 2.20 | 2.40 | E | 5.95 | 6.25 |
| B | 0.95 | 1.25 | e1 | 2.24 | 2.34 |
| b | 0.70 | 0.90 | e2 | 4.43 | 4.73 |
| b1 | 0.45 | 0.55 | L1 | 9.85 | 10.35 |
| C | 0.45 | 0.55 | L2 | 1.70 | 2.00 |
| D | 6.45 | 6.75 | L3 | 0.60 | 0.90 |
| D1 | 5.10 | 5.50 | K | 0.00 | 0.10 |

TO-252

印章说明 / Marking Instructions



说明：

BR： 为公司代码

4N65S： 为型号代码

****： 为生产批号代码，随生产批号变化

Note:

BR: Company Code

4N65S: Product Type Code

****: Lot No. Code, code change with Lot No

回流焊温度曲线图(无铅) / Temperature Profile for IR Reflow Soldering(Pb-Free)

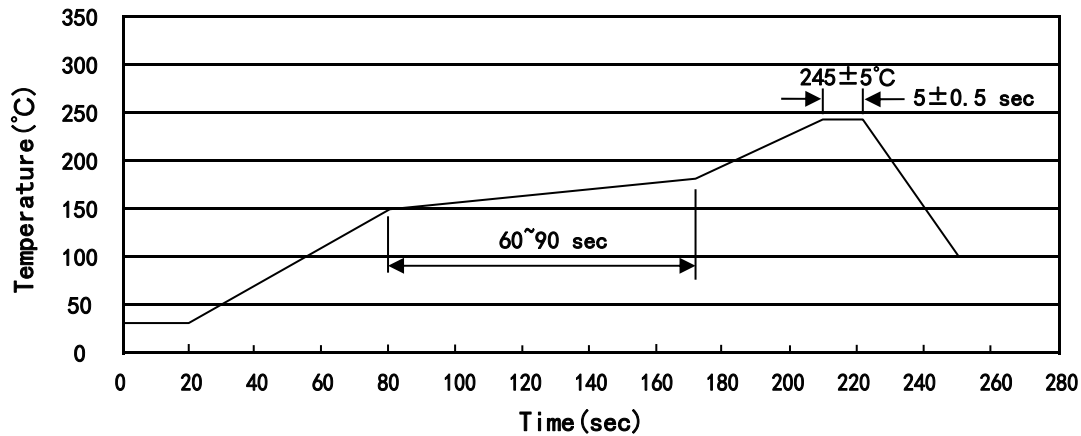

说明：

- 1、预热温度 150~180°C，时间 60~90sec;
- 2、峰值温度 245±5°C，时间持续为 5±0.5sec;
- 3、焊接制程冷却速度为 2~10°C/sec.

Note:

- 1.Preheating:150~180°C, Time:60~90sec.
- 2.Peak Temp.:245±5°C, Duration:5±0.5sec.
3. Cooling Speed: 2~10°C/sec.

耐焊接热试验条件 / Resistance to Soldering Heat Test Conditions

温度：260±5°C

时间：10±1 sec.

Temp.:260±5°C

Time:10±1 sec

包装规格 / Packaging SPEC.

卷盘包装 / REEL

| Package Type 封装形式 | Units 包装数量 | | | | | Dimension 包装尺寸 (unit: mm ³) | | |
|----------------------|--------------------|-------------------------|------------------------|------------------------------|------------------------|---|-------------|-------------|
| | Units/Reel 只/卷盘 | Reels/Inner Box 卷盘/盒 | Units/Inner Box 只/盒 | Inner Boxes/Outer Box 盒/箱 | Units/Outer Box 只/箱 | Reel | Inner Box 盒 | Outer Box 箱 |
| TO-252 | 2,500 | 2 | 5,000 | 6 | 30,000 | 13" ×16 | 360×360×50 | 380×335×366 |

套管包装 / TUBE

| Package Type 封装形式 | Units 包装数量 | | | | | Dimension 包装尺寸 (unit: mm ³) | | |
|----------------------|--------------------|-------------------------|------------------------|------------------------------|------------------------|---|-------------|-------------|
| | Units/Tube 只/套管 | Tubes/Inner Box 套管/盒 | Units/Inner Box 只/盒 | Inner Boxes/Outer Box 盒/箱 | Units/Outer Box 只/箱 | Tube 套管 | Inner Box 盒 | Outer Box 箱 |
| TO-251/252 | 75 | 48 | 3,600 | 5 | 18,000 | 526×20.5×5.25 | 555×164×50 | 575×290×180 |

使用说明 / Notices