

BRD65R380C

Rev.B May.-2022

描述 / Descriptions

TO-252 塑封封装 N 沟道 650V 超结工艺功率场效应管。

N-CHANNEL 650V Super-Junction Power MOSFET in a TO-252 Plastic Package.

特征 / Features

$R_{DS(on)}$ 小, 门电荷低, C_{rss} 小, 开关速度快, 无卤产品。

Low $R_{DS(on)}$, low gate charge, low C_{rss} , fast switching, HF Product.

用途 / Applications

用于低压电路如: 汽车电路、DC/DC 转换、便携式产品的电源高效转换。

Suited for low voltage applications such as automotive, DC/DC Converters, and high efficiency switching for power management in portable and battery operated products.

内部等效电路 / Equivalent Circuit

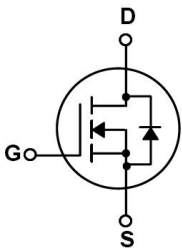

引脚排列 / Pinning

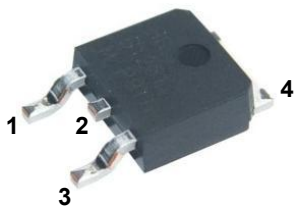

PIN 1 : G

PIN 2 : D

PIN 3 : S

PIN 4 : D

印章代码 / Marking

见印章说明。 See Marking Instructions.

极限参数 / Absolute Maximum Ratings(Ta=25°C)

参数 Parameter	符号 Symbol	数值 Rating	单位 Unit
Drain-Source Voltage	V_{DSS}	650	V
Drain Current	$I_D(T_C=25^\circ C)$	11	A
Drain Current - Pulsed	I_{DM}	44	A
Gate-Source Voltage	V_{GS}	± 30	V
Single Pulsed Avalanche Energy	E_{AS}	277	mJ
Avalanche Current	I_{AS}	8	A
Power Dissipation	$P_D(T_C=25^\circ C)$	125	W
Operating and Storage Temperature Range	T_J, T_{STG}	-55 to 150	$^\circ C$
Junction-to-Case	$R_{\theta JC}$	1	$^\circ C/W$
Junction-to-Ambient	$R_{\theta JA}$	55	$^\circ C/W$

电性能参数 / Electrical Characteristics(Ta=25°C)

参数 Parameter	符号 Symbol	测试条件 Test Conditions	最小值 Min	典型值 Typ	最大值 Max	单位 Unit
Drain-Source Breakdown Voltage	BV_{DSS}	$V_{GS}=0V$ $I_D=250\mu A$	650	700		V
Zero Gate Voltage Drain Current	I_{DSS}	$V_{DS}=650V$ $V_{GS}=0V$ $T_J=25^\circ C$			1.0	μA
Gate-Body Leakage Current, Forward	I_{GSS}	$V_{GS}=\pm 30V$			± 100	nA
Gate Threshold Voltage	$V_{GS(th)}$	$V_{DS}=V_{GS}$ $I_D=250\mu A$	2.5	3.3	4.5	V
Static Drain-Source On-Resistance	$R_{DS(on)}$	$V_{GS}=10V$ $I_D=5.5A$		320	380	m Ω
Drain-Source Diode Forward Voltage	V_{SD}	$V_{GS}=0V$ $I_{SD}=1A$ $T_J=25^\circ C$			1.2	V
Gate Resistance	R_g	$V_{GS}=0V$ $f=1.0MHz$		4.1		Ω
Input Capacitance	C_{iss}	$V_{DS}=100V$ $V_{GS}=0V$ $f=1.0MHz$		735		pF
Output Capacitance	C_{oss}			35		pF
Reverse Transfer Capacitance	C_{rss}			0.45		pF
Turn-On Delay Time	$t_{d(on)}$	$V_{DS}=400V$ $I_D=5.5A$ $R_G=25\Omega$ $V_{GS}=10V$		16.3		ns
Turn-On Rise Time	t_r			35		ns
Turn-Off Delay Time	$t_{d(off)}$			78		ns
Turn-Off Fall Time	t_f			39.5		ns

电性能参数 / Electrical Characteristics(Ta=25°C)

参数 Parameter	符号 Symbol	测试条件 Test Conditions	最小值 Min	典型值 Typ	最大值 Max	单位 Unit
Continuous Diode Forward Current	I_S				11	A
Total Gate Charge	Q_g	$V_{DS}=480V$ $I_D=5.5A$ $V_{GS}=10V$		19.2		nC
Gate-Source Charge	Q_{gs}			3.1		nC
Gate-Drain Charge	Q_{gd}			8.2		nC
Reverse recovery time	T_{rr}	$V_R=400V$, $I_F=5.5A$, $di_F/dt=100A/\mu s$		310		ns
Reverse recovery charge	Q_{rr}			2.8		uC

电参数曲线图 / Electrical Characteristic Curve

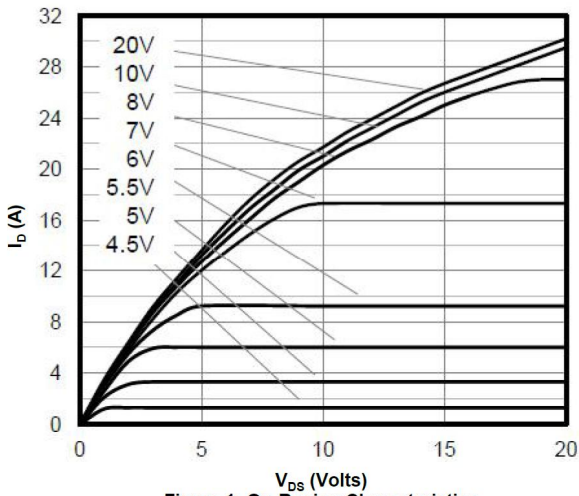

Figure 1: On-Region Characteristics

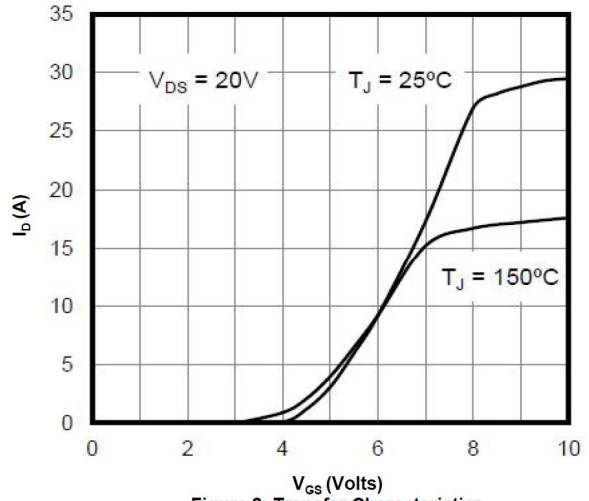

Figure 2: Transfer Characteristics

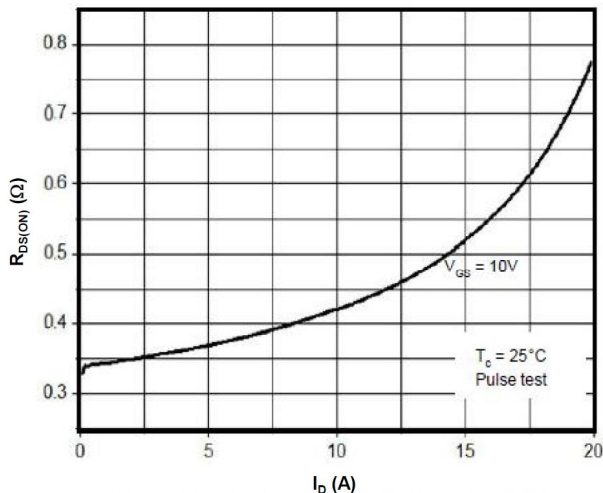

Figure 3: On-Resistance vs. Drain Current and Gate Voltage

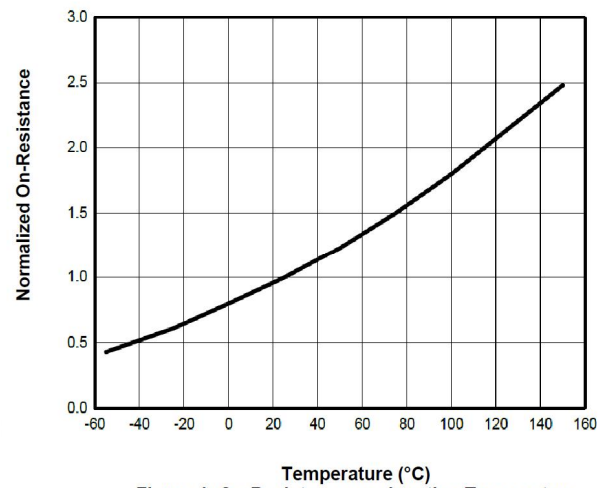

Figure 4: On-Resistance vs. Junction Temperature

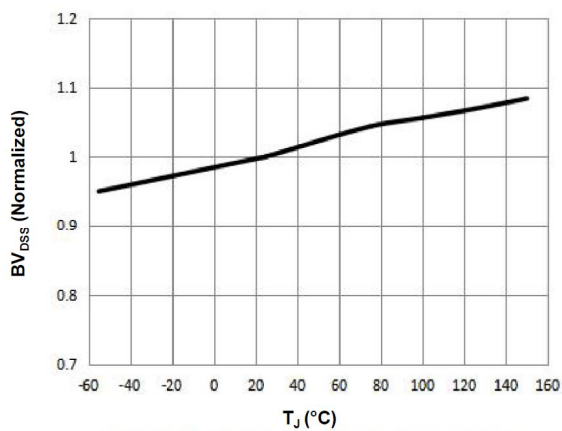

Figure 5: Break Down vs. Junction Temperature

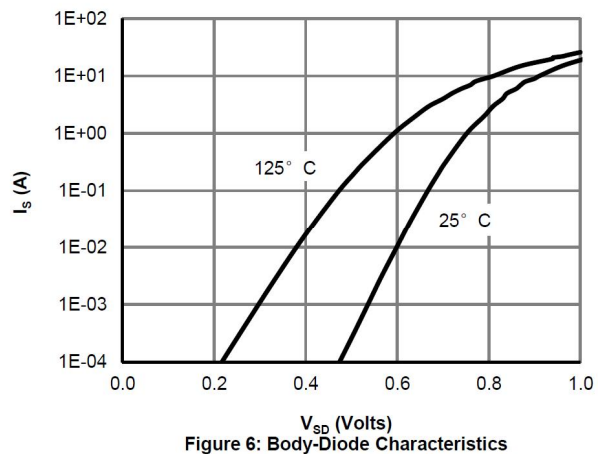

Figure 6: Body-Diode Characteristics

电参数曲线图 / Electrical Characteristic Curve

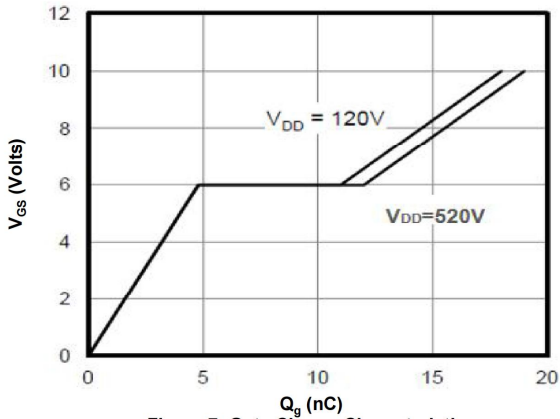

Figure 7: Gate-Charge Characteristics

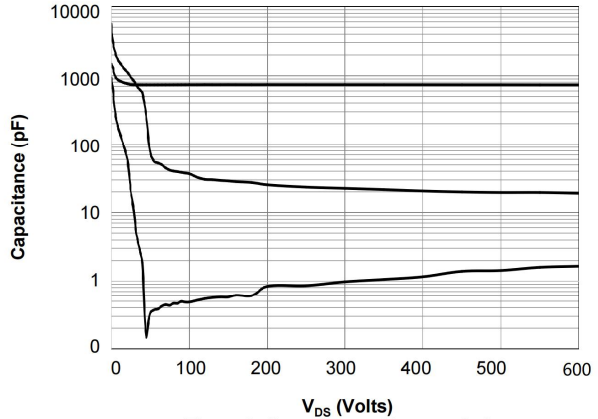

Figure 8: Capacitance Characteristics

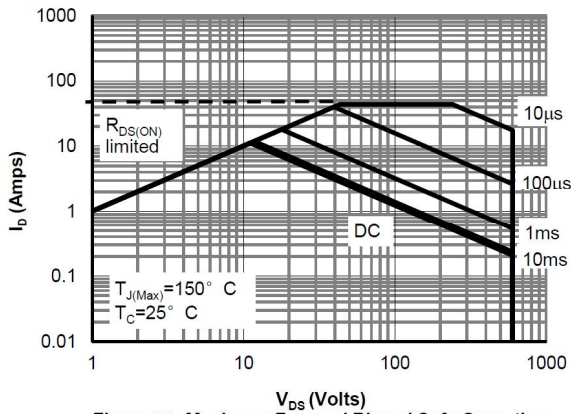

Figure 09: Maximum Forward Biased Safe Operating Area

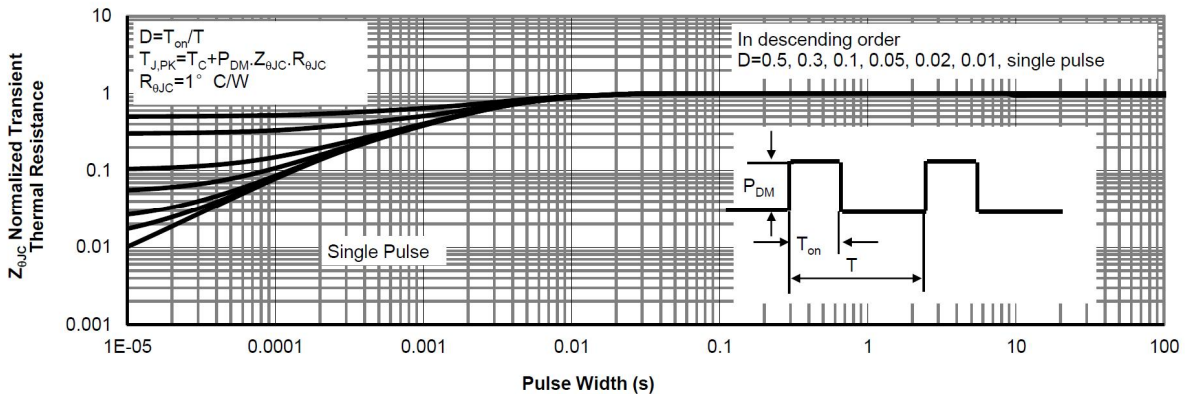
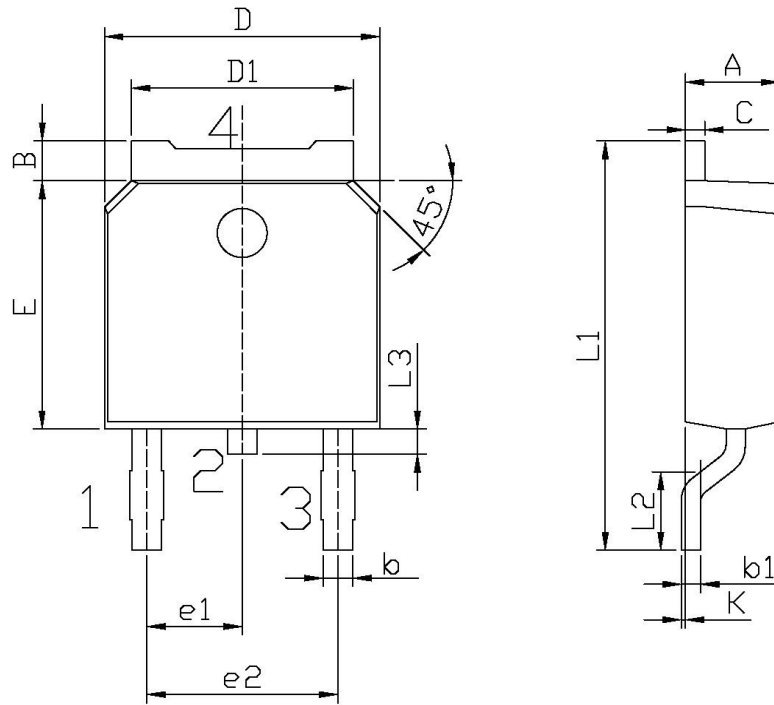

Figure 10: Normalized Maximum Transient Thermal Impedance

外形尺寸图 / Package Dimensions



单位: mm

Symbol	Dimensions In Millimeters		Symbol	Dimensions In Millimeters	
	Min	Max		Min	Max
A	2.20	2.40	E	5.95	6.25
B	0.95	1.25	e1	2.24	2.34
b	0.70	0.90	e2	4.43	4.73
b1	0.45	0.55	L1	9.85	10.35
C	0.45	0.55	L2	1.70	2.00
D	6.45	6.75	L3	0.60	0.90
D1	5.10	5.50	K	0.00	0.10

TO-252

印章说明 / Marking Instructions

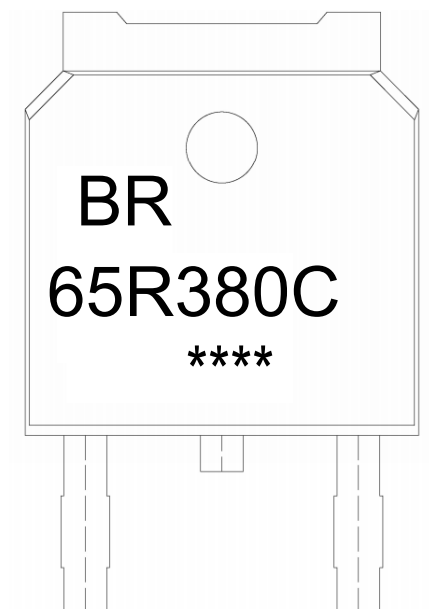

说明：

BR： 为公司代码

65R380C： 为型号代码

****： 为生产批号代码，随生产批号变化

Note:

BR: Company Code

65R380C: Product Type Code

****: Lot No. Code, code change with Lot No

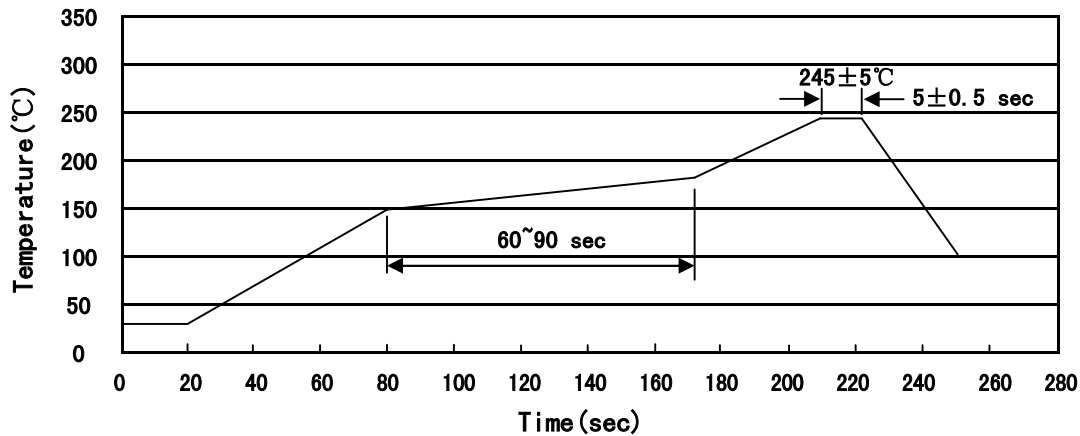
回流焊温度曲线图(无铅) / Temperature Profile for IR Reflow Soldering(Pb-Free)

说明：

- 1、预热温度 150~180°C，时间 60~90sec;
- 2、峰值温度 245±5°C，时间持续为 5±0.5sec;
- 3、焊接制程冷却速度为 2~10°C/sec.

Note:

- 1.Preheating:150~180°C, Time:60~90sec.
- 2.Peak Temp.:245±5°C, Duration:5±0.5sec.
3. Cooling Speed: 2~10°C/sec.

耐焊接热试验条件 / Resistance to Soldering Heat Test Conditions

温度：260±5°C

时间：10±1 sec.

Temp.:260±5°C

Time:10±1 sec

包装规格 / Packaging SPEC.

卷盘包装 / REEL

Package Type 封装形式	Units 包装数量					Dimension 包装尺寸 (unit: mm ³)		
	Units/Reel 只/卷盘	Reels/Inner Box 卷盘/盒	Units/Inner Box 只/盒	Inner Boxes/Outer Box 盒/箱	Units/Outer Box 只/箱	Reel	Inner Box 盒	Outer Box 箱
TO-252	2,500	2	5,000	6	30,000	13" ×16	360×360×50	380×335×366

套管包装 / TUBE

Package Type 封装形式	Units 包装数量					Dimension 包装尺寸 (unit: mm ³)		
	Units/Tube 只/套管	Tubes/Inner Box 套管/盒	Units/Inner Box 只/盒	Inner Boxes/Outer Box 盒/箱	Units/Outer Box 只/箱	Tube 套管	Inner Box 盒	Outer Box 箱
TO-251/252	75	48	3,600	5	18,000	526×20.5×5.25	555×164×50	575×290×180

使用说明 / Notices